

PETITE SERIES

Interior Ceiling Recessed 

Monochromatic: Management through:

- DMX 512 controllers & converters 0-10V or 1-10V or simple pushbuttons.
- Wireless IR & RF control units.
- DALI Protocol devices.
- Dimmable through ELECTRON Constant Current LED drivers.
- Ideal for decorative lighting.

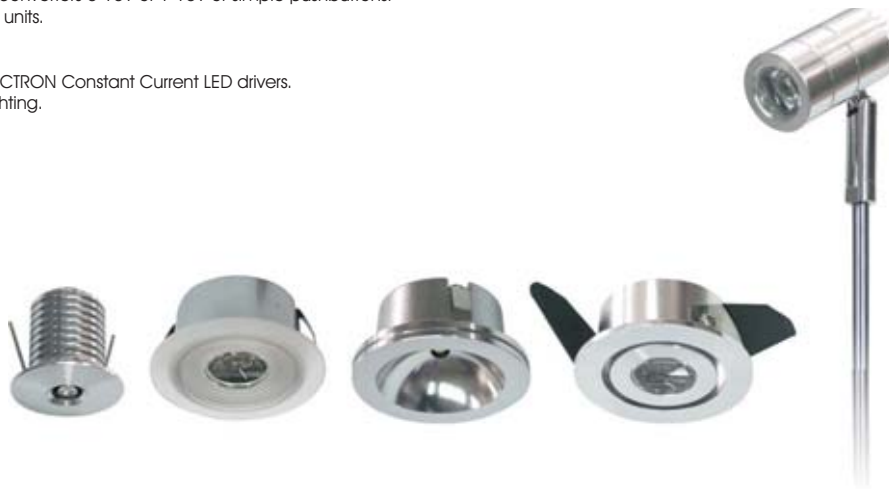

Code	Model	No.LED	Colour*	Watt	Current**	∅ Diameter		
------	-------	--------	---------	------	-----------	------------	---	--

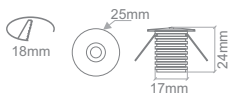

ALI.101	ULTRA	1	COOL WHITE	1W	350mA	25mm	120°	Dimmable
ALI.102	ULTRA	1	WARM WHITE	1W	350mA	25mm	120°	Dimmable
ALI.104	ULTRA	1	BLUE	1W	350mA	25mm	120°	Dimmable

*Other colours available upon request.

**Adjustable intensity with ELECTRON dimmable constant current LED drivers.

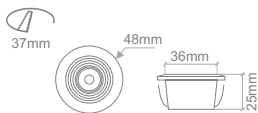

ALI.111	ACRYLIC	1	COOL WHITE	1W	350mA	48mm	DIFUSE	Dimmable
ALI.112	ACRYLIC	1	WARM WHITE	1W	350mA	48mm	DIFUSE	Dimmable
ALI.113	ACRYLIC	1	BLUE	1W	350mA	48mm	DIFUSE	Dimmable
ALI.114	ACRYLIC	1	RED	1W	350mA	48mm	DIFUSE	Dimmable
ALI.115	ACRYLIC	1	GREEN	1W	350mA	48mm	DIFUSE	Dimmable

*Other colours available upon request.

**Adjustable intensity with ELECTRON dimmable constant current LED drivers.

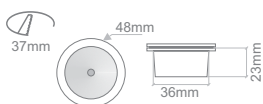

ALI.107	ANTI-GLARE	1	COOL WHITE	1W	350mA	48mm	120°	Dimmable
ALI.108	ANTI-GLARE	1	WARM WHITE	1W	350mA	48mm	120°	Dimmable

*Other colours available upon request.

**Adjustable intensity with ELECTRON dimmable constant current LED drivers.

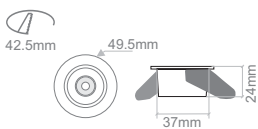

ALI.109	MOVABLE	1	COOL WHITE	1W	350mA	49.5mm	30°	Dimmable
ALI.110	MOVABLE	1	WARM WHITE	1W	350mA	49.5mm	30°	Dimmable

*Other colours available upon request.

**Adjustable intensity with ELECTRON dimmable constant current LED drivers.

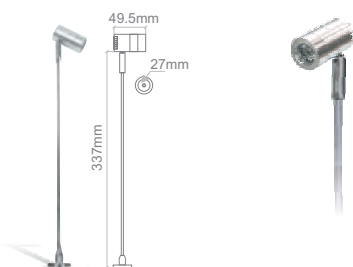

ALI.116	SPOTLIGHT	1	COOL WHITE	1W	350mA	364x49.5mm	45°	Dimmable
ALI.117	SPOTLIGHT	1	WARM WHITE	1W	350mA	364x49.5mm	45°	Dimmable

*Other colours available upon request.

**Adjustable intensity with ELECTRON dimmable constant current LED drivers.



Interior Ceiling Recessed

BAROLO

Monochromatic: Management through:

- DMX 512 controllers & converters 0-10V or 1-10V or simple push buttons.
- Wireless IR & RF control units.
- DALI Protocol devices.
- Dimmable through ELECTRON Constant Current LED drivers.
- Decorative lighting.
- Available in 30° & 60°.
- Ideal for ambient lighting in combination with ceiling recessed frames.

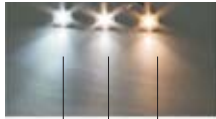

6.400K 4.100K 3.000K

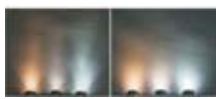

30° 60°

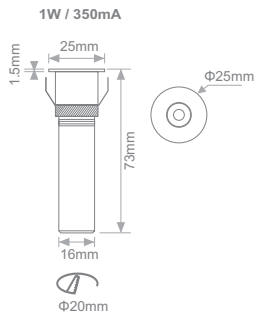
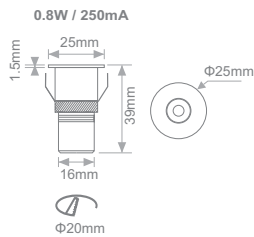

Code	No.LED	Colour Temperature*	Watt	Current**	Diameter	Beam Angle	Dimmable
<i>0.8W / 250mA</i>							
LED.230	1	6.400K	0.8W	250mA	25mm	30°	Dimmable
LED.231	1	4.100K	0.8W	250mA	25mm	30°	Dimmable
LED.232	1	3.000K	0.8W	250mA	25mm	30°	Dimmable
LED.233	1	6.400K	0.8W	250mA	25mm	60°	Dimmable
LED.234	1	4.100K	0.8W	250mA	25mm	60°	Dimmable
LED.235	1	3.000K	0.8W	250mA	25mm	60°	Dimmable

*Other colours available upon request.

**Adjustable intensity with ELECTRON dimmable constant current LED drivers.

Code	No.LED	Colour Temperature*	Watt	Current**	Diameter	Beam Angle	Dimmable
<i>1W / 350mA</i>							
LED.227	1	6.400K	1W	350mA	25mm	30°	Dimmable
LED.228	1	4.100K	1W	350mA	25mm	30°	Dimmable
LED.229	1	3.000K	1W	350mA	25mm	30°	Dimmable
LED.236	1	6.400K	1W	350mA	25mm	60°	Dimmable
LED.237	1	4.100K	1W	350mA	25mm	60°	Dimmable
LED.238	1	3.000K	1W	350mA	25mm	60°	Dimmable

*Other colours available upon request.

**Adjustable intensity with ELECTRON dimmable constant current LED drivers.

Accessories

(Barolo LEDs not included)

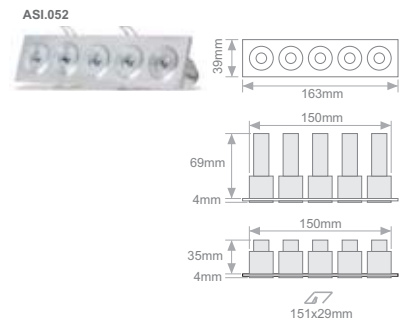
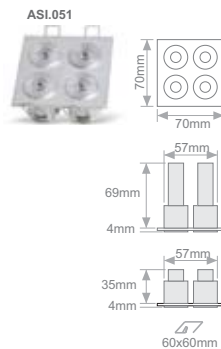
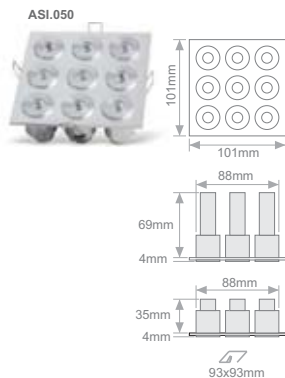

STARLIGHT SERIES

Interior Ceiling Recessed 

Monochromatic: Management through:

- DMX 512 controllers & converters 0-10V or 1-10V or simple push buttons.
- Wireless IR & RF control units.
- DALI Protocol devices.
- Dimmable Constant Current LED Spots 350mA.
- Ceiling or wall recessed spotlights ideal for decorative applications.
- Diffused light emission and chromed aluminium finish.
- Different shapes of diffusers.



Code	Model	No.LED	Colour Temperature*	Watt/Current**	Dimensions		Finish	
ALI.206	CRYSTAL	1	3000-3500K	1W / 350mA	Φ60x85mm	Diffused	Chromed Aluminium	Dimmable
ALI.207	CRYSTAL	1	5500-6000K	1W / 350mA	Φ60x85mm	Diffused	Chromed Aluminium	Dimmable
ALI.208	RHOMB	1	3000-3500K	1W / 350mA	Φ30x83mm	Diffused	Chromed Aluminium	Dimmable
ALI.209	RHOMB	1	5500-6000K	1W / 350mA	Φ30x83mm	Diffused	Chromed Aluminium	Dimmable
ALI.210	BALL	1	3000-3500K	1W / 350mA	Φ30x83mm	Diffused	Chromed Aluminium	Dimmable
ALI.211	BALL	1	5500-6000K	1W / 350mA	Φ30x83mm	Diffused	Chromed Aluminium	Dimmable
ALI.212	DIAMOND	1	3000-3500K	1W / 350mA	Φ23x95mm	Diffused	Chromed Aluminium	Dimmable
ALI.213	DIAMOND	1	5500-6000K	1W / 350mA	Φ23x95mm	Diffused	Chromed Aluminium	Dimmable
ALI.214	DIAMOND MINI	1	3000-3500K	0.5W / 160mA	Φ12x67mm	Diffused	Chromed Aluminium	Dimmable
ALI.215	DIAMOND MINI	1	5500-6000K	0.5W / 160mA	Φ12x67mm	Diffused	Chromed Aluminium	Dimmable

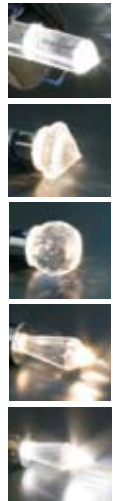

*Other colours available upon request.

**Adjustable intensity with ELECTRON dimmable constant current LED drivers.

RGB: Management through:

- DMX 512 controllers & converters 0-10V or 1-10V or simple push buttons.
- Wireless IR & RF control units.
- DALI Protocol devices.
- Ceiling or wall recessed spotlights ideal for decorative applications.
- Diffused light emission and chromed aluminium finish.



Model	No.LED	Colour	Watt	Voltage	Dimensions		Finish	
DIAMOND RGB /CC*	1	RGB	0.25W	5VDC	Φ23x65mm	Diffused	Chromed Aluminium	Dimmable

*CC=Common Cathode

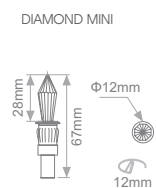
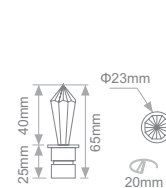
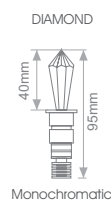
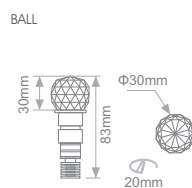
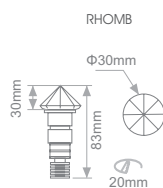
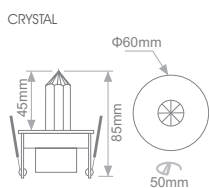



Interior Ceiling Recessed

CUBIC + EYE + EYE SQUARE

Monochromatic: Management through:

- DMX 512 controllers & converters 0-10V or 1-10V or simple push buttons.
- Wireless IR & RF control units.
- DALI Protocol devices.
- Dimmable Constant Current LED Spots 350/500mA
- Ceiling, wall recessed and semi-recessed spotlights.
- Ideal for ambient and decorative lighting applications.
- Made by pure aluminium.



Code	Model	No.LED	Colour Temperature*	Watt / Current**	Dimensions		Finish		
ALI.216	CUBIC	1	3000-3500K	1W / 350mA	25x25x58mm	30°	Aluminium MAT	Dimmable	
ALI.217	CUBIC	1	5500-6000K	1W / 350mA	25x25x58mm	30°	Aluminium MAT	Dimmable	
ALI.218	EYE	1	3000-3500K	1W / 350mA	Φ23x36mm	120°	Nickel Mat	Dimmable	
ALI.219	EYE	1	5500-6000K	1W / 350mA	Φ23x36mm	120°	Nickel Mat	Dimmable	
ALI.220	EYE SQUARE	1	3000-3500K	1W / 350mA	23x23x36mm	120°	Nickel Mat	Dimmable	
ALI.221	EYE SQUARE	1	5500-6000K	1W / 350mA	23x23x36mm	120°	Nickel Mat	Dimmable	

*Other colours available upon request.

**Adjustable intensity with ELECTRON dimmable constant current LED drivers.

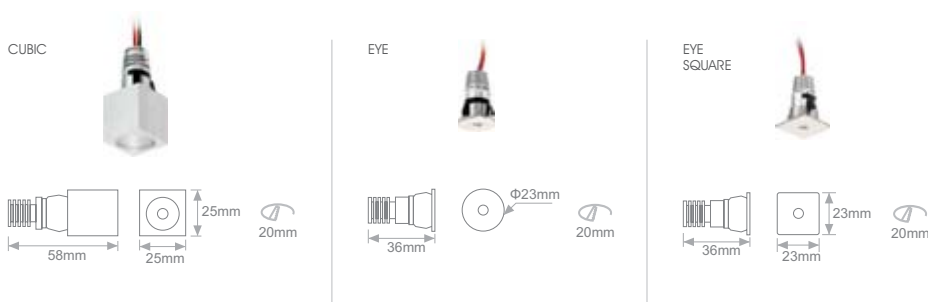



FRAME + FRAME SQUARE

Interior Ceiling Recessed 

Monochromatic: Management through:

- DMX 512 controllers & converters 0-10V or 1-10V or simple push buttons.
- Wireless IR & RF control units.
- DALI Protocol devices.
- Dimmable Constant Current LED Spots 350mA
- Ceiling or wall recessed spotlights ideal for signage or decorative applications.
- Diffused light emissions.
- Round and Square shapes.
- High anti-glare protection.



Code	Model	No.LED	Colour Temperature*	Watt / Current**	Dimensions		Finish			
ALI.222	FRAME	1	3000-3500K	1W / 350mA	Φ40x46mm	Diffused	Frost Diffuser	Dimmable		
ALI.223	FRAME	1	5500-6000K	1W / 350mA	Φ40x46mm	Diffused	Frost Diffuser	Dimmable		
ALI.224	FRAME SQUARE	1	3000-3500K	1W / 350mA	40x40x46mm	Diffused	Frost Diffuser	Dimmable		
ALI.225	FRAME SQUARE	1	5500-6000K	1W / 350mA	40x40x46mm	Diffused	Frost Diffuser	Dimmable		

*Other colours available upon request.

**Adjustable intensity with ELECTRON dimmable constant current LED drivers.

FRAME

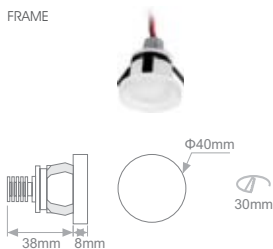

FRAME SQUARE

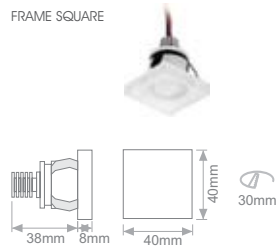



Interior Ceiling Recessed

TORN + TORN MINI

Monochromatic: Management through:

- DMX 512 controllers & converters 0-10V or 1-10V or simple push buttons.
- Wireless IR & RF control units.
- DALI Protocol devices.
- Dimmable Constant Current LED Spots 350/500mA
- Recessed spotlights with high anti-glare protection.
- Ideal for decorative lighting and retail applications.
- Trimless effect design, white painted body.
- Made by pure aluminium.



Code	Model	No.LED	Colour Temperature*	Watt / Current**	Dimensions	Beam Angle	Finish		
ALI.226	TORN	1	3000-3500K	1W / 350mA	Φ35x50mm	60°	White Painted Aluminium	Dimmable	
ALI.227	TORN	1	5500-6000K	1W / 350mA	Φ35x50mm	60°	White Painted Aluminium	Dimmable	
ALI.228	TORN MINI	1	3000-3500K	1W / 350mA	Φ23x50mm	30°	White Painted Aluminium	Dimmable	
ALI.229	TORN MINI	1	5500-6000K	1W / 350mA	Φ23x50mm	30°	White Painted Aluminium	Dimmable	

*Other colours available upon request.

**Adjustable intensity with ELECTRON dimmable constant current LED drivers.

TORN



TORN MINI







DECO-S + DECO-M

Interior Ceiling Recessed 

- **Monochromatic:** Management through:
 - DMX 512 controllers & converters 0-10V or 1-10V or simple push buttons.
 - Wireless IR & RF control units.
 - DALI Protocol devices.
- Dimmable Constant Current LED Spots 350mA
- Recessed spotlights with high anti-glare protection.
- Ideal for decorative lighting and retail applications.
- High flexibility through adjustable movement.
- Made by pure aluminium, chromed aluminium finish.



Code	Model	No.LED	Colour Temperature*	Watt / Current**	Dimensions		Finish		
ALI.230	DECO-S	1	3000-3500K	1W / 350mA	Φ26x31mm	40°	Chromed Aluminium	Dimmable	
ALI.231	DECO-S	1	5500-6000K	1W / 350mA	Φ26x31mm	40°	Chromed Aluminium	Dimmable	
ALI.232	DECO-M	1	3000-3500K	1W / 350mA	Φ26x42mm	20°	Chromed Aluminium	Dimmable	
ALI.233	DECO-M	1	5500-6000K	1W / 350mA	Φ26x42mm	20°	Chromed Aluminium	Dimmable	

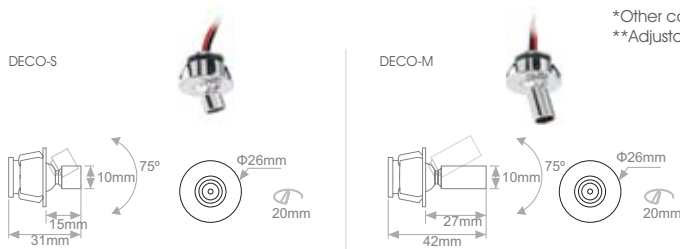

*Other colours available upon request.
**Adjustable intensity with ELECTRON dimmable constant current LED drivers.

LUPUS

- **Monochromatic:** Management through:
 - DMX 512 controllers & converters 0-10V or 1-10V or simple push buttons.
 - Wireless IR & RF control units.
 - DALI Protocol devices.
- Dimmable through ELECTRON Constant Current LED drivers.
- Ideal for ambient & decorative lighting.



Code	Model	No.LED	Colour*	Watt	Current**	Ø Diameter		Finish	
ALI.120	LUPUS	1	COOL WHITE	3W	350mA	35mm	25°	Dimmable	
ALI.121	LUPUS	1	WARM WHITE	3W	350mA	35mm	25°	Dimmable	

*Other colours available upon request.
**Adjustable intensity with ELECTRON dimmable constant current LED drivers.

