

ARC

Aluminium Profile

- ARC aluminium profile ideal for concealed lighting.
- Ideal depth solution for demanding architectural applications.
- Available with transparent, milky, milky satin or ruled cover.
- Special design and construction to meet the most demanding lighting designs.

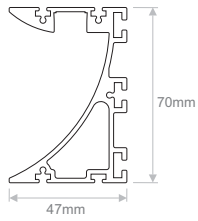

RECESSED

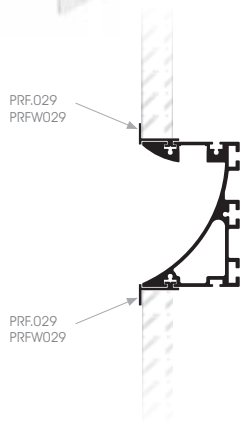

TRIMLESS

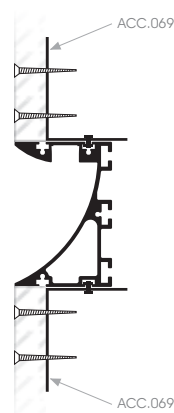

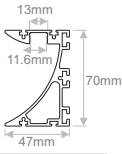







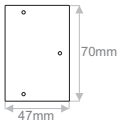

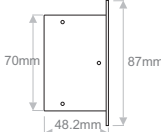

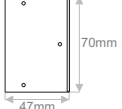

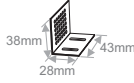

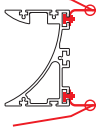









Image	Code	Description	Length	Design-Detail
	PRF.038 PRFW038	ARC alum.prof. / Non-Anodized ARC alum.prof. / White Painted	2m 2m	
	PRF.029 PRFW029	ANGLE alum.prof. / Non-Anodized ANGLE alum.prof. / White Painted	2m 2m	
	COV.023 COV.024 COV.025 COV.026	POLYCARBONATE MILKY COVER POLYCARBONATE MILKY SATIN COVER POLYCARBONATE RULED COVER POLYCARBONATE CLEAR COVER	2m 2m 2m 2m	
	COV.018 COV.017 COV.007	POLYCARBONATE CLEAR COVER POLYCARBONATE OPAL COVER PMMA FROSTED COVER	2m 2m 2m	
	CAP062 CAPW062	END CAP / Non-Anodized END CAP / White Painted		
	CAP063 CAPW063	RECESSED END CAP / Non-Anodized RECESSED END CAP / White Painted		
	CAP069	BASE CAP		
	ACC.069	PERFORATED HOLDER FOR PLASTERBOARD		
	ACC.071	RETAINING SPRING		
	ACC.056	EXTENSION LINE		
	ACC.057	90° CORNER EXTENSION		
	ACC.058	60° CORNER EXTENSION		
	ACC.059	45° CORNER EXTENSION		

ARC 2

Aluminium Profile

- ARC2 aluminium profile with double strip installation.
- Ideal depth solution for demanding architectural applications.
- Available with transparent, milky, milky satin or ruled cover.
- Special design and construction to meet the most demanding lighting designs.

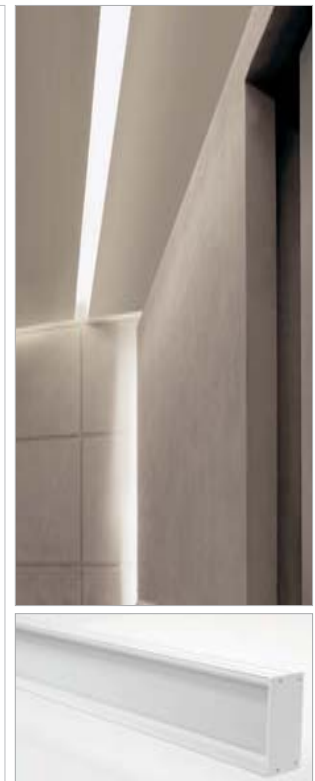
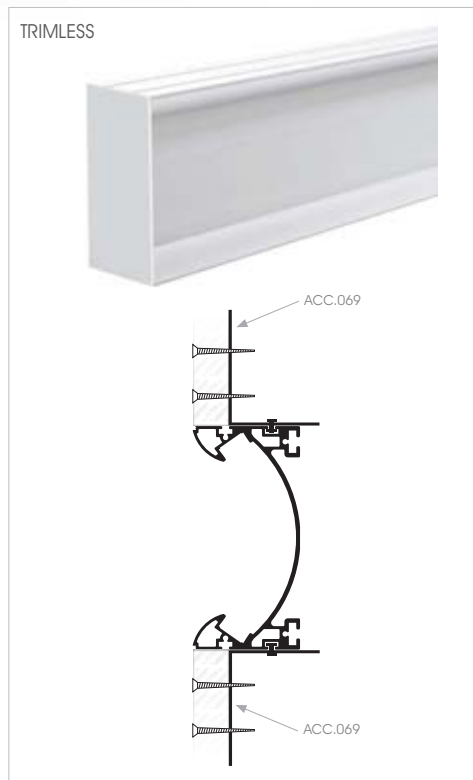
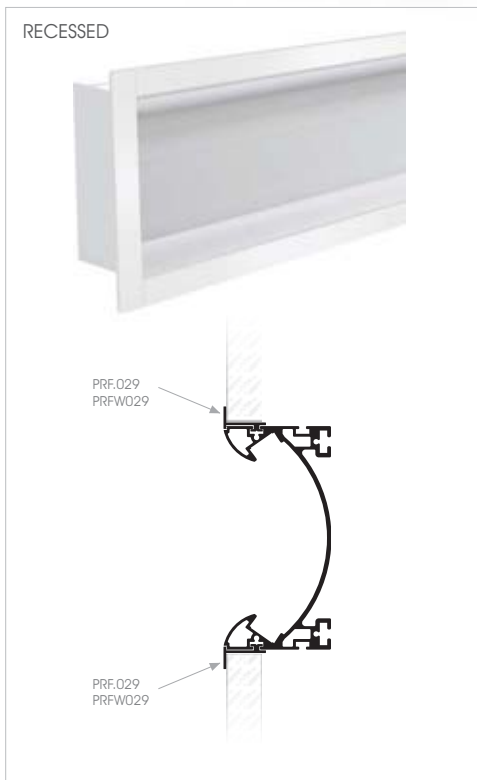
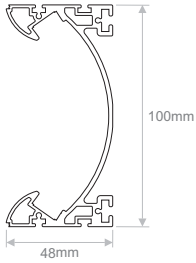

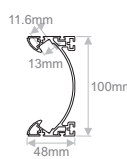







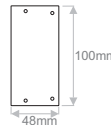

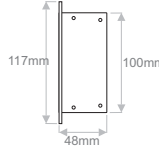

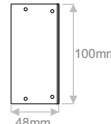

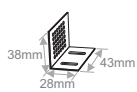











Image	Code	Description	Length	Design-Detail
	PRF.039 PRFW039	ARC2 alum.prof. / Non-Anodized ARC2 alum.prof. / White Painted	2m 2m	
	PRF.029 PRFW029	ANGLE alum.prof. / Non-Anodized ANGLE alum.prof. / White Painted	2m 2m	
	COV.023 COV.024 COV.025 COV.026	POLYCARBONATE MILKY COVER POLYCARBONATE MILKY SATIN COVER POLYCARBONATE RULED COVER POLYCARBONATE CLEAR COVER	2m 2m 2m 2m	
	COV.018 COV.017 COV.007	POLYCARBONATE CLEAR COVER POLYCARBONATE OPAL COVER PMMA FROSTED COVER	2m 2m 2m	
	CAP.064 CAPW064	END CAP / Non-Anodized END CAP / White Painted		
	CAP.065 CAPW065	RECESSED END CAP / Non-Anodized RECESSED END CAP / White Painted		
	CAP.070	BASE CAP		
	ACC.069	PERFORATED HOLDER FOR PLASTERBOARD		
	ACC.071	RETAINING SPRING		
	ACC.056	EXTENSION LINE		
	ACC.057	90° CORNER EXTENSION		
	ACC.058	60° CORNER EXTENSION		
	ACC.059	45° CORNER EXTENSION		

ARC 3

Aluminium Profile

Aluminium Profiles 

- ARC3 aluminium profile ideal for concealed lighting.
- Ideal depth solution for demanding architectural applications.
- Available with transparent, milky, milky satin or ruled cover.
- Special design and construction to meet the most demanding lighting designs.

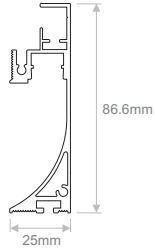

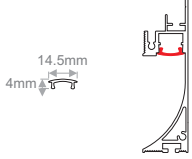





Image	Code	Description	Length	Design-Detail
	PRF.051 PRFW051	ARC3 alum.prof. / Non-Anodized ARC3 alum.prof. / White Painted	2m 2m	
	COV.023 COV.024 COV.025 COV.026	POLYCARBONATE MILKY COVER POLYCARBONATE MILKY SATIN COVER POLYCARBONATE RULED COVER POLYCARBONATE CLEAR COVER	2m 2m 2m 2m	
	COV.018 COV.017 COV.007	POLYCARBONATE CLEAR COVER POLYCARBONATE OPAL COVER PMMA FROSTED COVER	2m 2m 2m	
	CAP.093 CAPW.093	END CAP / Non-Anodized END CAP / White Painted		
	ACC.056	EXTENSION LINE		
	ACC.057	90° CORNER EXTENSION		
	ACC.058	60° CORNER EXTENSION		
	ACC.059	45° CORNER EXTENSION		

