

- TETRA PLUS aluminium profile system ideal for linear LED lighting applications.
- Accessories for recessed, surface with hinge, surface, trimless and pendant applications.
- Variety of accessories for different corner and line extensions.
- Special design and construction to meet the most demanding lighting designs.

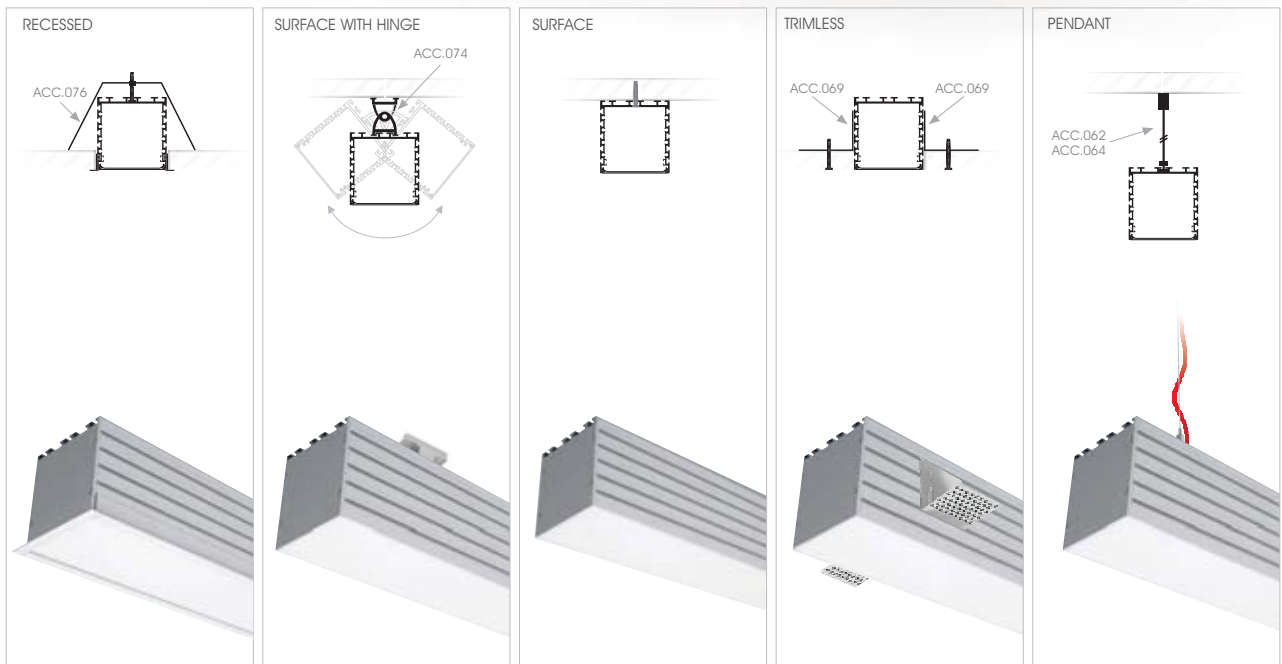
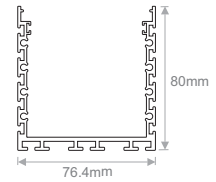



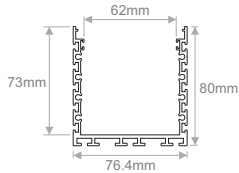

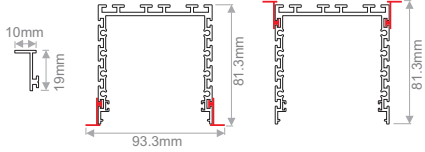

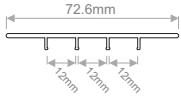

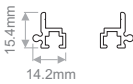

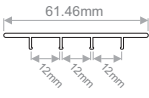

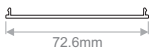



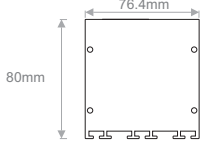

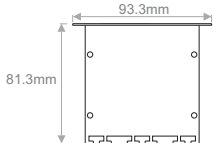
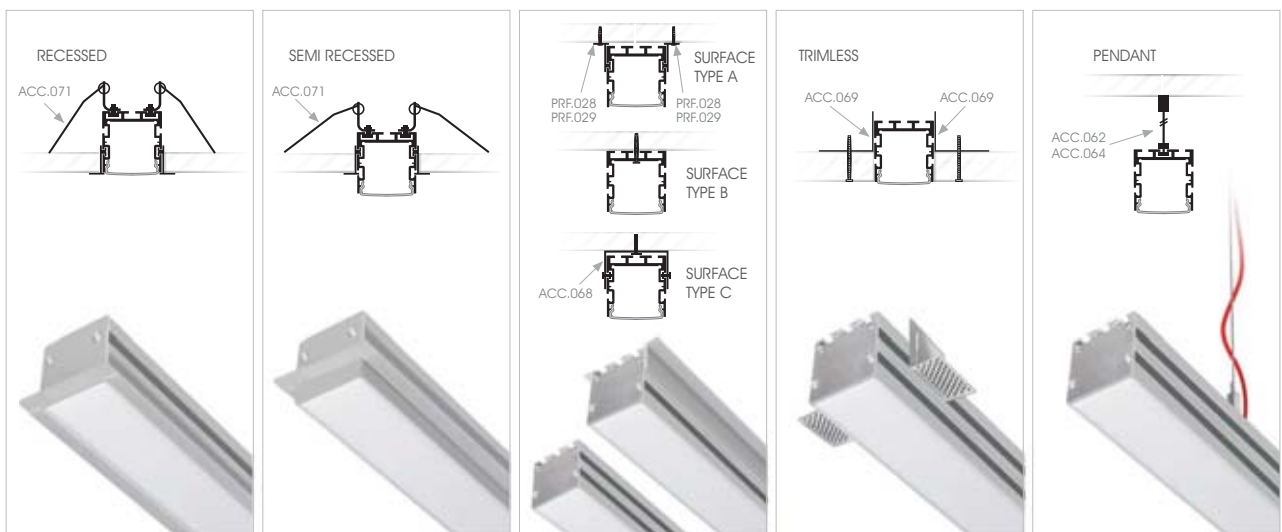
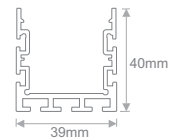
Image	Code	Description	Length	Design-Detail
	PRF.041 PRF.042	TETRA PLUS alum.prof. / Anodized TETRA PLUS alum.prof. / Non-Anodized	2m 2m	
	PRF.028 PRF.029	ANGLE alum.prof. / Anodized ANGLE alum.prof. / Non-Anodized	2m 2m	
	PRF.047	SLIDING BASE 3-BANK	2m	
	PRF.048	INNER HOLDERS	2m	
	PRF.044	SLIDING BASE 3-BANK INNER	2m	
	PRF.046	ALUMINIUM COVER / Non-Anodized	2m	
	COV.012	POLYCARBONATE SATIN COVER	2m	
	CAP.074	END CAP		
	CAP.081	RECESSED END CAP		

Image	Code	Description	Design-Detail
	ACC.076	RECESSED HOLDER	
	ACC.069	PERFORATED HOLDER FOR PLASTERBOARD	
	ACC.062 ACC.064	CEILING SUSPENSION INSTALLATION 150cm CEILING SUSPENSION INSTALLATION 300cm	
	ACC.083	ECO BRACKET	
	ACC.074	180 DEGREE BRACKET	
	ACC.056	EXTENSION LINE	
	ACC.057	90° CORNER EXTENSION	
	ACC.058	60° CORNER EXTENSION	
	ACC.059	45° CORNER EXTENSION	

- TETRA aluminium profile system ideal for linear LED lighting applications.
- Accessories for surface, semi recessed, recessed, trimless and pendant applications.
- Variety of accessories for different corner and line extensions.
- Special design and construction to meet the most demanding lighting designs.



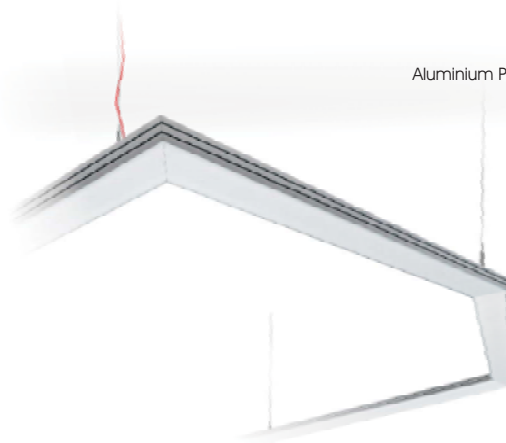



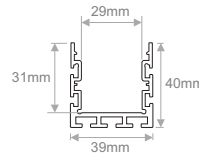

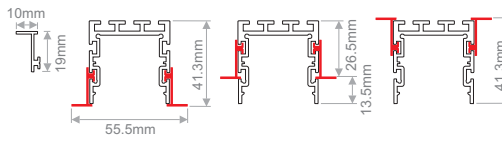

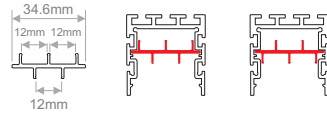



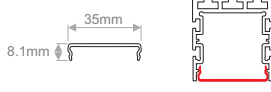

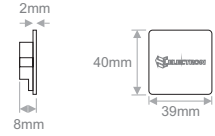

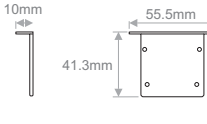

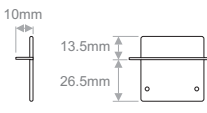

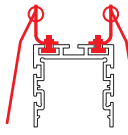
Image	Code	Description	Length	Design-Detail
	PRF.026 PRF.027	TETRA alum.prof. / Anodized TETRA alum.prof. / Non-Anodized	2m 2m	
	PRF.028 PRF.029	ANGLE alum.prof. / Anodized ANGLE alum.prof. / Non-Anodized	2m 2m	
	PRF.030	DUAL BAND SLIDING BASE	2m	
	ELA.016	ALUMINIUM SLIDING BASE (Thickness 2mm)	2m	
	COV.008 COV.009	PMMA SATIN COVER PMMA CLEAR COVER	2m 2m	
	CAP.092	END CAP		
	CAP.051	RECESSED END CAP		
	CAP.052	SEMI RECESSED END CAP		
	ACC.071	RETAINING SPRING		

Image	Code	Description	Design-Detail	
	ACC.069	PERFORATED HOLDER FOR PLASTERBOARD		
	ACC.068	CEILING SURFACE HOLDER		
	ACC.062 ACC.064	CEILING SUSPENSION INSTALLATION 150cm CEILING SUSPENSION INSTALLATION 300cm		
	ACC.070	HINGE		
	ACC.083	ECO BRACKET		
	ACC.074	180 DEGREE BRACKET		
		ACC.056	EXTENSION LINE	
		ACC.057	90° CORNER EXTENSION	
		ACC.058	60° CORNER EXTENSION	
		ACC.059	45° CORNER EXTENSION	